

SKATEPARKS



PHILOSOPHY

2

IDEA

Our ramps are designed for individual use and as well as for professional skate parks where various sport activities can be organized. This is a good solution for your leisure activities like roller-skating, skate boarding and BMX biking.

Professional skaters and others have taken part in developing and designing process of skating ramps and parks.

We have built our own skate park where we can test ramp models and make sure that the applied materials are suitable and resistant to wear if used intensively.

DIMENSIONS AND SAFETY REQUIREMENTS

Quality of the ramps meets the requirements of German standard DIN 33943 Rollsportgeräte Skateeinrichtungen; Begriffe, sicherheitstechnische Anforderungen, Prüfung that regulates the dimensions of the ramps, production and installation requirements.

APPLIED MATERIAL



In the production of ramps plywood overlaid with phenol film is applied. JSC Latvijas Finieris produced plywood is very durable and can be used in shuttering and bodywork flooring. It is produced from renewable resources, can be reused and easy utilizable.

RIGAPLY, RIGA FORM and RIGA HEKSA plywood is applied in production of ramps.

1) RIGA PLY WG/WG applied as a bottom layer of the skating surface. It helps to reduce production and also ramp exploitation costs.

2) RIGA FORM F/F d.br. used in production of frame construction and sides of the ramp.

3) RIGA HEXA d.br. plywood with higher resistance to wear and anti slip properties is used as skating surface. The thickness of such a surface is 6.5 mm.



Edges of the details are sealed. It makes elastic protective layer and decreases wood swelling.

The upper layer of the ramp can be changed if work out by taking off the old layer and fixing the new one instead.



We can also offer to use a material produced by the company SKATELITE for the surface of the ramp. This material is advertised as really good for ramp surfaces. Ramps are equipped with metal parts that make the construction appearance more visible and perform safety instructions. Metal parts are zincified that reduces corrosion. Ramps are easy to transport and assemble.

The width of standard construction is 1,5 m. Putting them together you can make combined skating ramps and parks as you like.

QUARTERPIPES

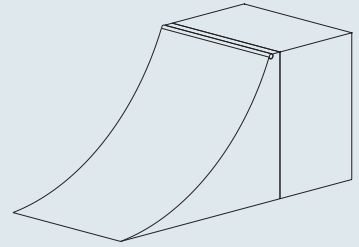

BANKS

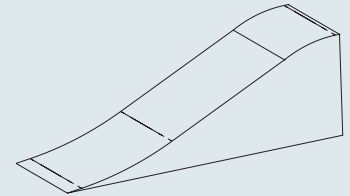

FUN BOX

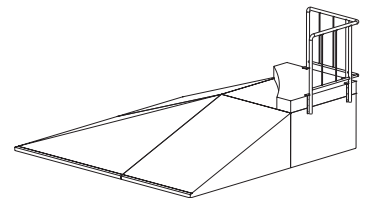

PYRAMIDS

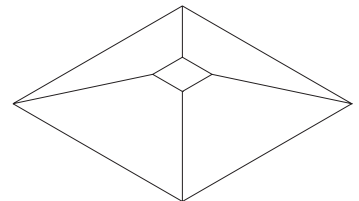

SLIDEBOX

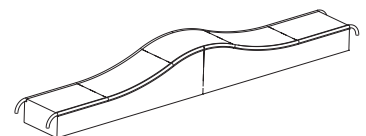

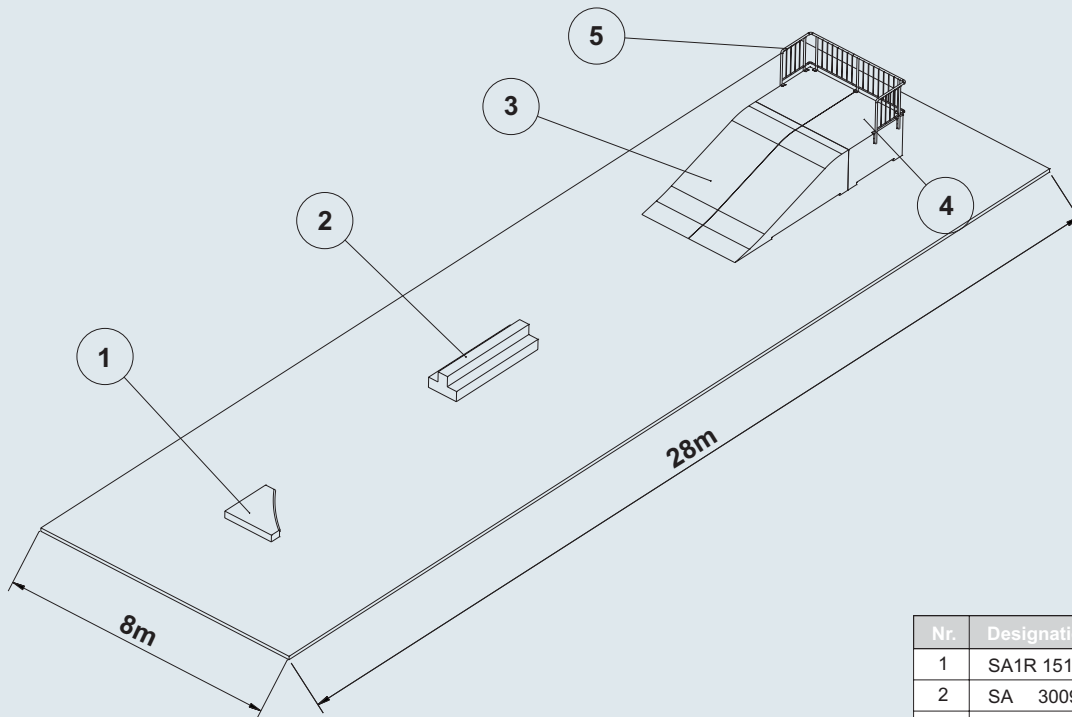

Nr.	Designation	Pcs.
1	SA1R 151502	1
2	SA 300906	1
3	SL1R 411512	2
4	SL 201512	2
5	M3 300912	1

SA 300906

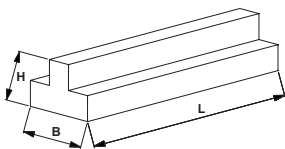

SA1R 151502

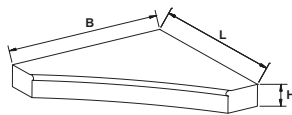

SL1R 411512

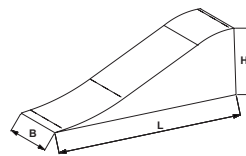

SL 201512

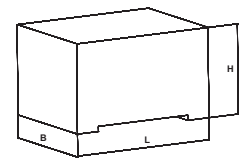

M3 300912

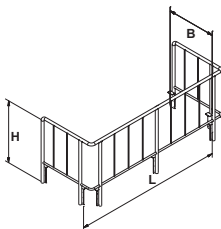

Nr.	Designation	Pcs.
1	PR1K 311515	4
2	SA3R 600808	1
3	PR1R 301010	1
4	M3 300912	2

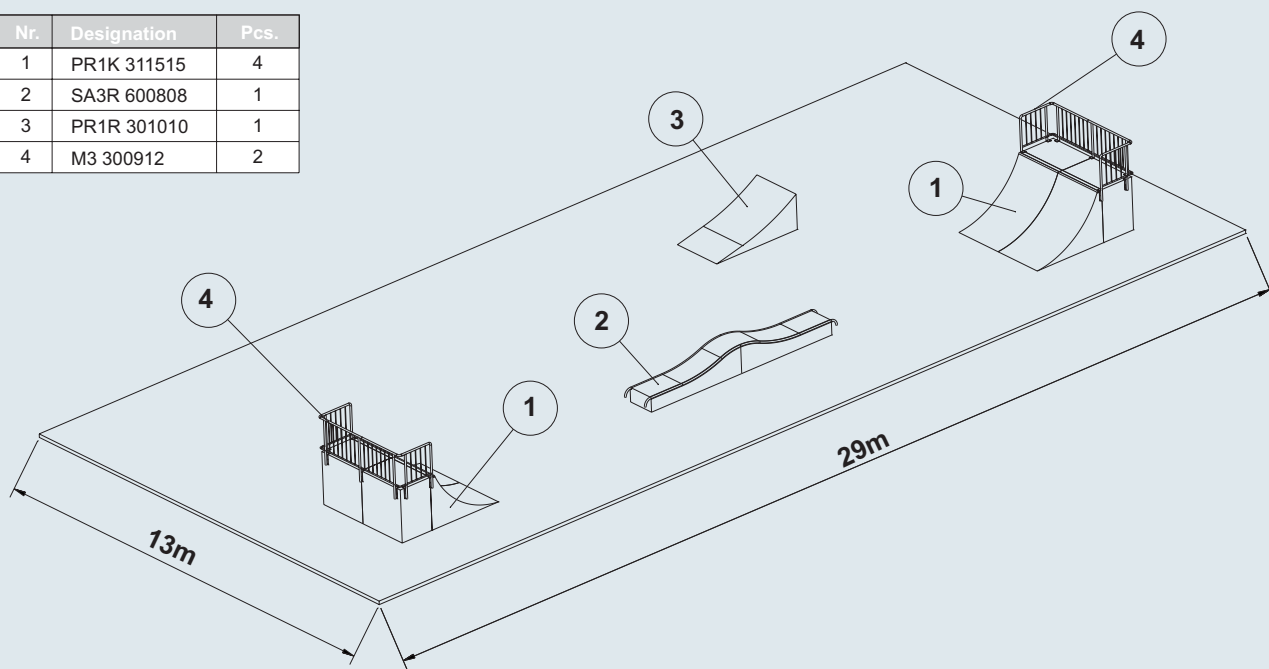

PR1K 311515

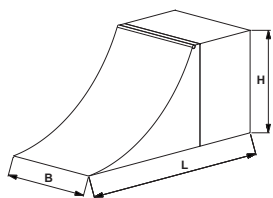

PR1R 301010

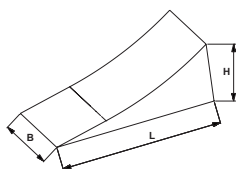

SA3R 600808

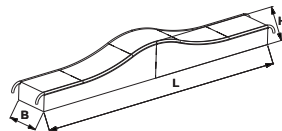

M3 300912

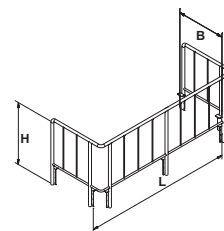

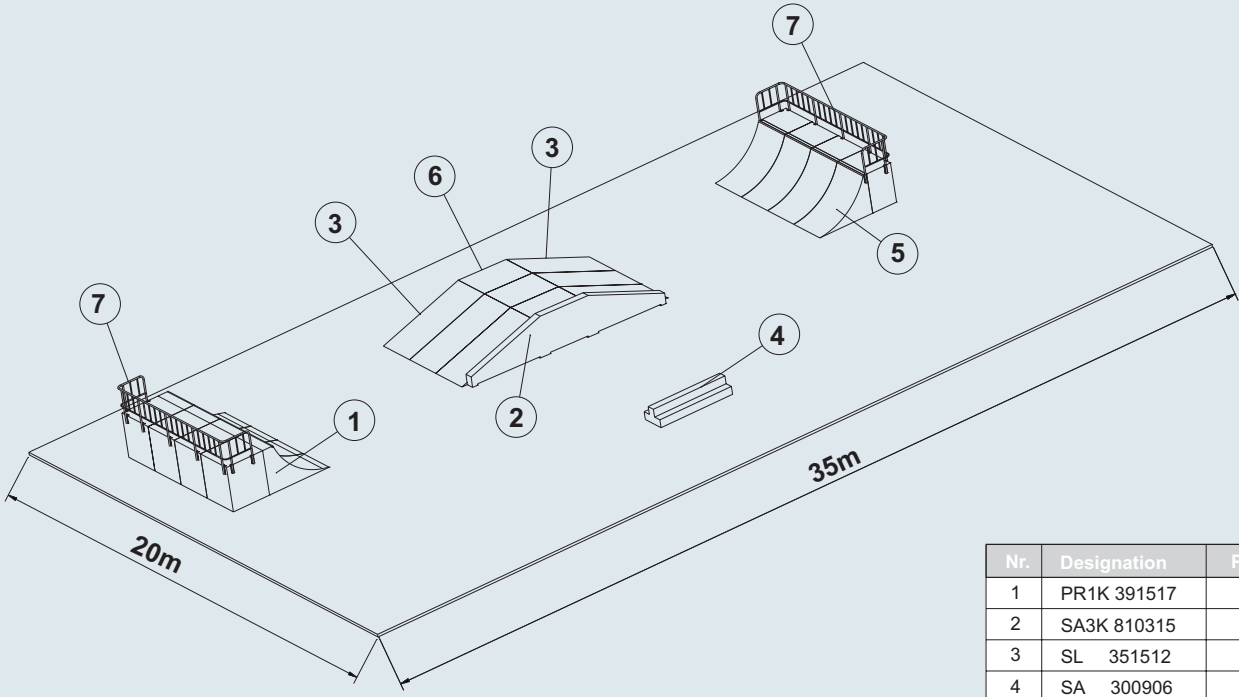

Nr.	Designation	Pcs.
1	PR1K 391517	4
2	SA3K 810315	1
3	SL 351512	6
4	SA 300906	1
5	PR1K 311515	4
6	SL 201512	3
7	M5 600912	2

PR1K 391517 PR1K 311515

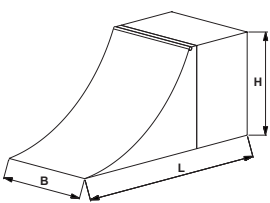

SA3K 810315

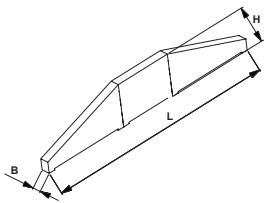

SL 351512

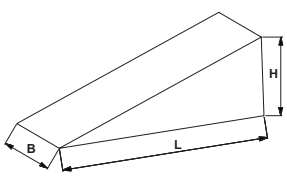

SA 300906

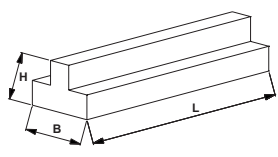

SL 201512

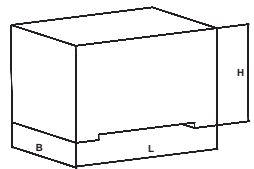

M5 600912

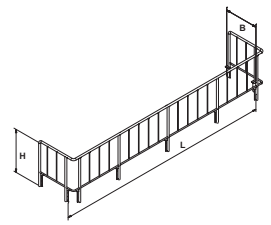

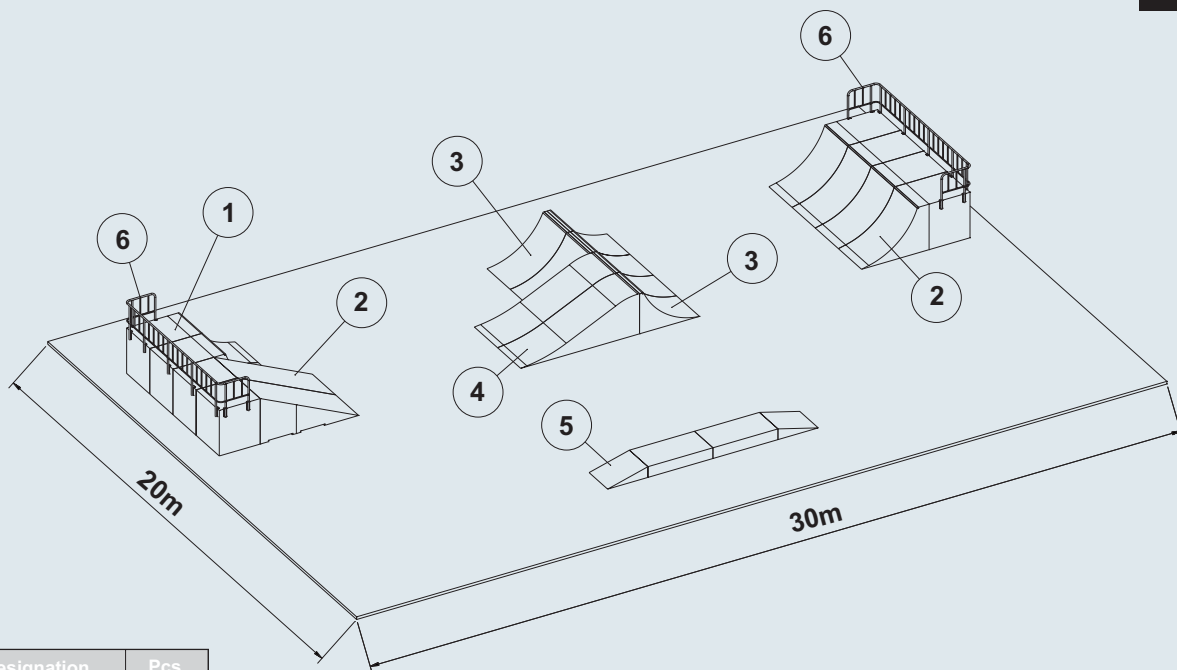

Nr.	Designation	Pcs.
1	PR1K 391517	6
2	SL4K 433017	1
3	PR 211515	6
4	SL1R 441515	2
5	SA4K 501004	1
6	M5 600912	2

PR1K 391517

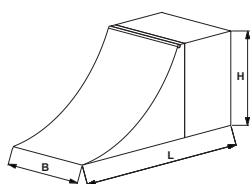

SL4K 433017

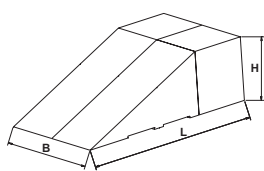

PR 211515

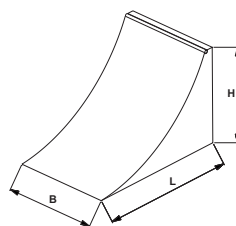

SL1R 441515

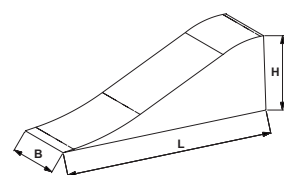

SA4K 501004

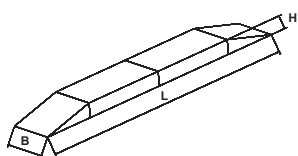

M5 600912

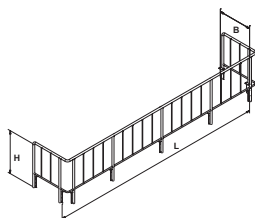

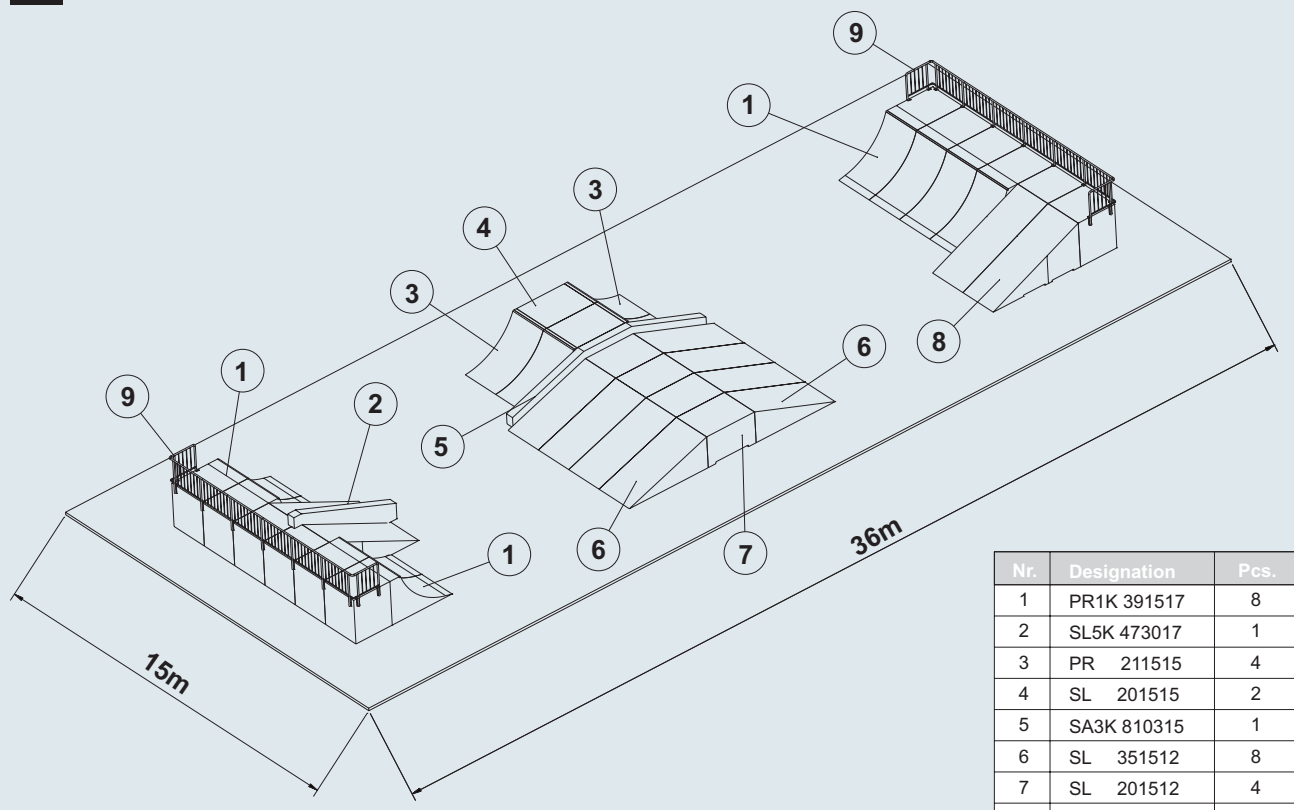

Nr.	Designation	Pcs.
1	PR1K 391517	8
2	SL5K 473017	1
3	PR 211515	4
4	SL 201515	2
5	SA3K 810315	1
6	SL 351512	8
7	SL 201512	4
8	SL4K 433017	1
9	M7 900912	2

PR1K 391517

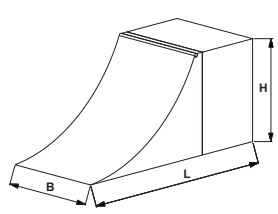

SL5K 473017

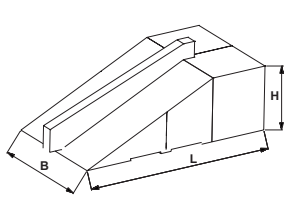

PR 211515

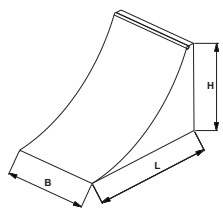

SL 201512 SL 201515

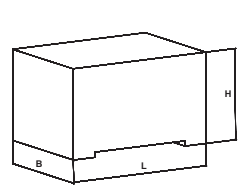

SA3K 810315

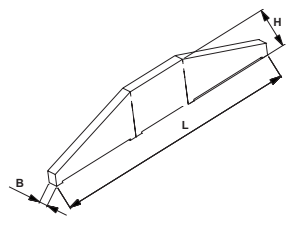

SL 351512

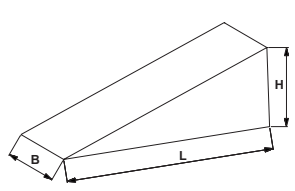

SL4K 433017

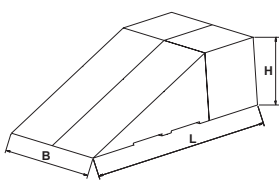

M7 900912

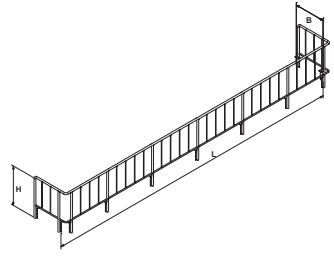

Nr.	Designation	Pcs.
1	SL 201512	6
2	PR1K 391517	6
3	PR 211515	4
4	PR3R 491515	2
5	SL 241509	4
6	SA3K 810315	1
7	PR1R 301010	2
8	SL5K 473017	1
9	M5 600912	2
10	SL 151509	2
11	M4 450912	2
12	SL 351512	6

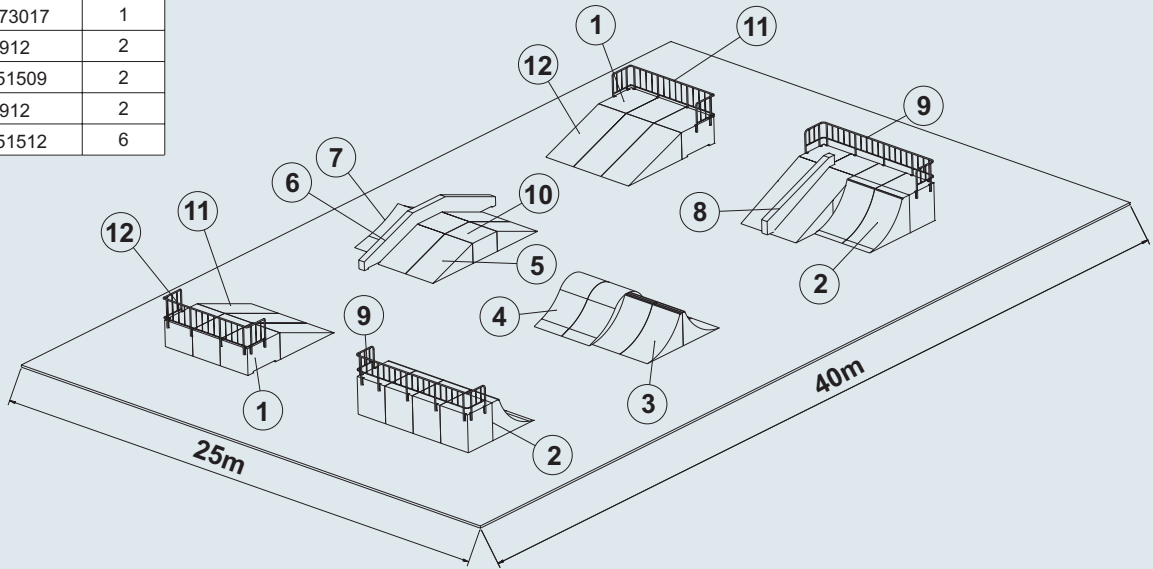

SL 201512 SL 151509

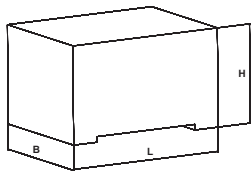

PR1K 391517

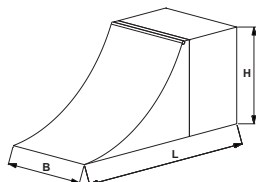

PR 211515

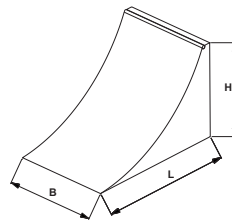

PR3R 491515

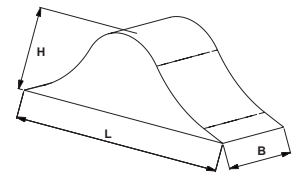

SL 241509 SL 351512

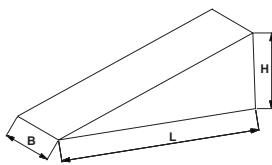

SA3K 810315

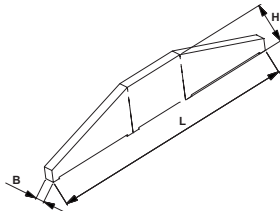

PR1R 301010

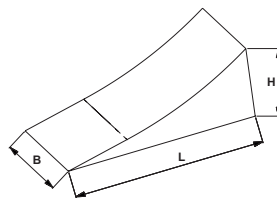

SL5K 473017

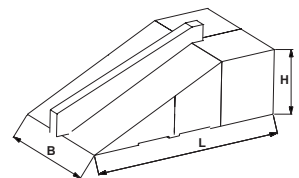

M5 600912

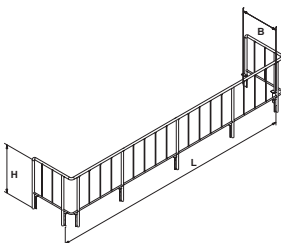

M4 450912

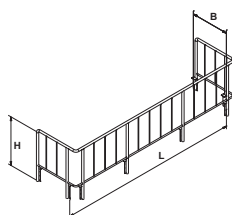

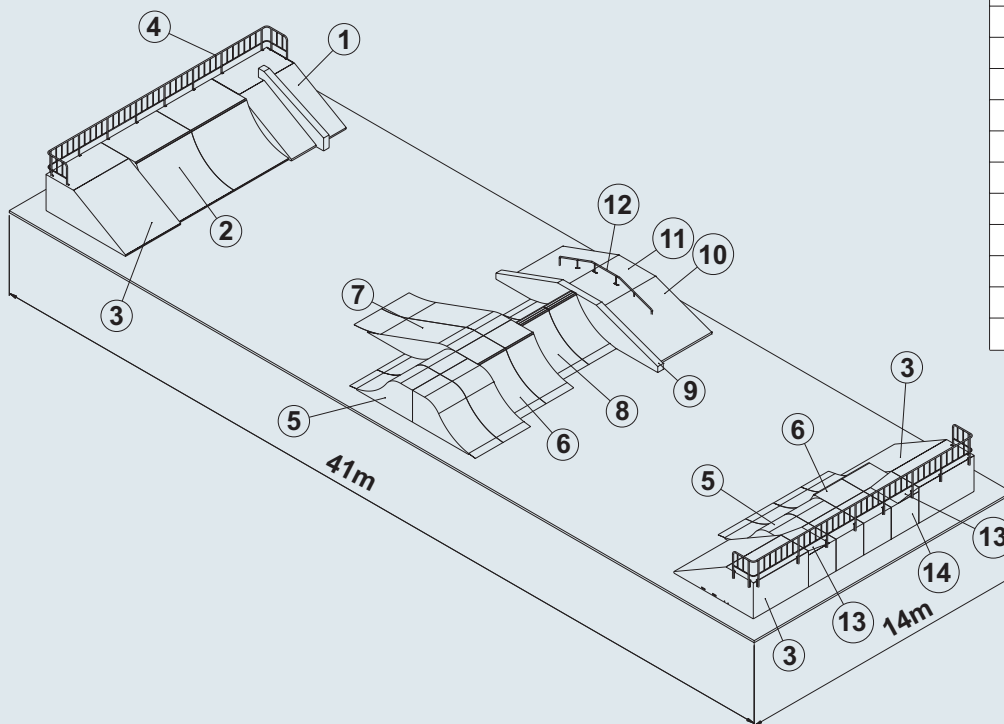

Nr.	Designation	Pcs.
1	SL5K 473017	1
2	PR1K 391517	4
3	SL4K 433017	3
4	M8 1200912	2
5	PR2R 311515	6
6	PR1K 311515	4
7	SL1R 441515	2
8	PR 211515	4
9	SA3K 810315	1
10	SL 351512	4
11	SL 201512	2
12	M2 500010	1
13	SL 121502	2
14	SL 151515	4

SL5K 473017

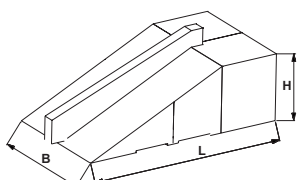

PR1K 391517 PR1K 311515

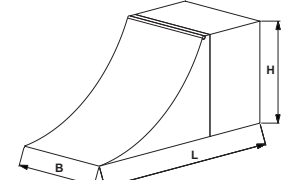

SL4K 433017

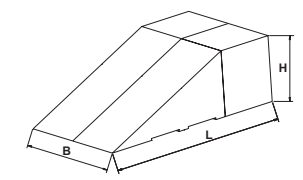

PR2R 311515

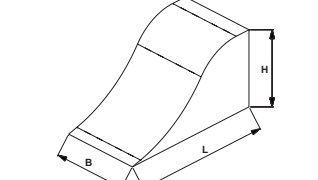

SL1R 441515

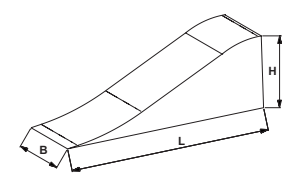

PR 211515

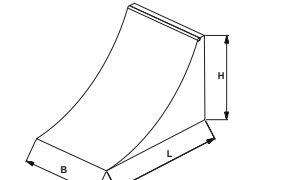

SA3K 810315

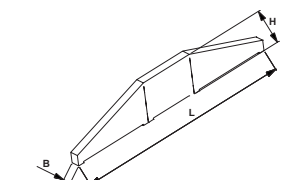

SL 351512

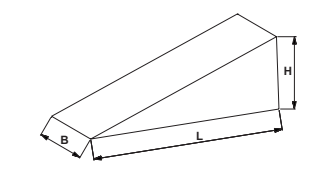

SL 201512 SL 151515

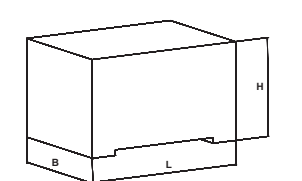

SL 121502

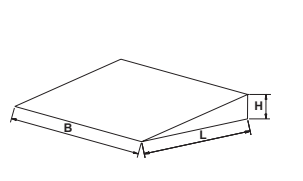

M2 500010

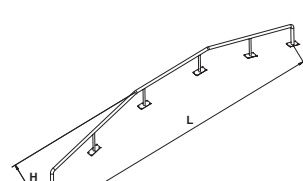

M8 1200912

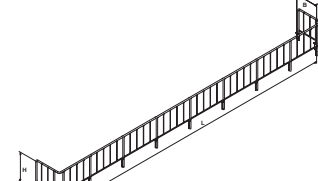

Nr.	Designation	Pcs.
1	TK5K 383811	1
2	SL1R 441515	2
3	PR 211515	6
4	PR1K 391517	4
5	M5 600912	2
6	PM9K 818112	1
7	SA3R 600808	1
8	TK5KR383811	1
9	TK9K 753412	1
10	PR1K 311515	4
11	SR1 104515	1
12	M1 250010	1

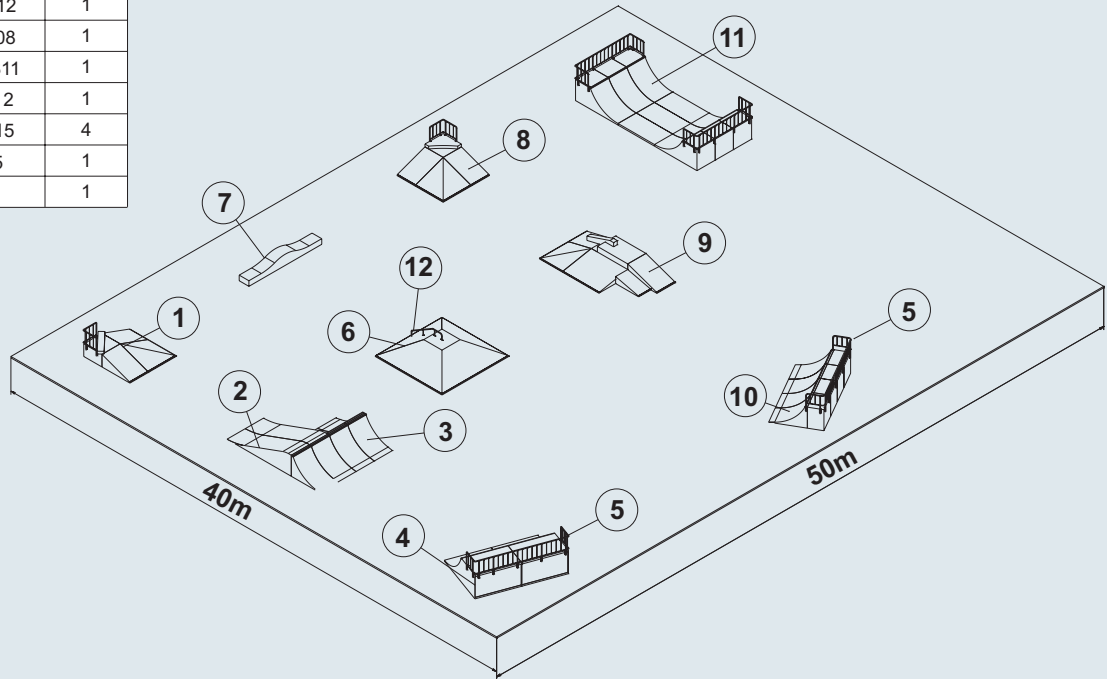

TK5K 383811

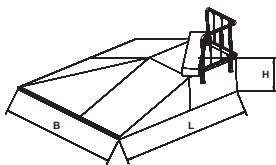

SL1R 441515

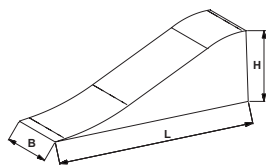

PR 211515

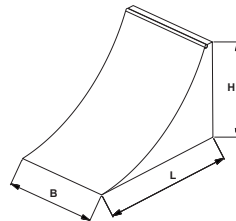

PR1K 391517 PR1K 311515

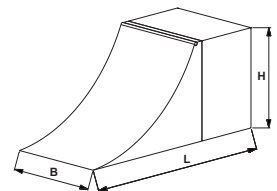

PM9K 818112

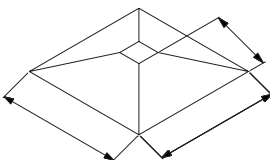

SA3R 600808

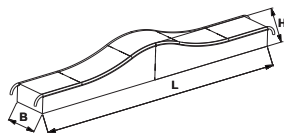

TK5KR 383811

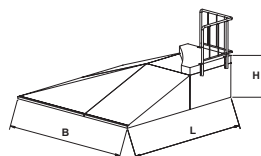

TK9K 753412

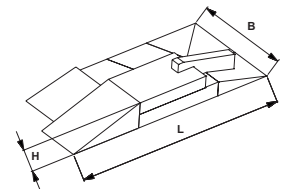

PR1K 311515

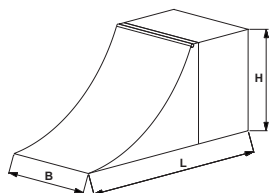

SR1 104515

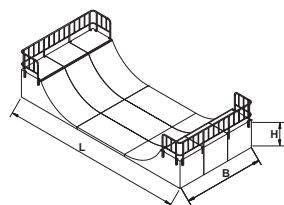

M1 250010

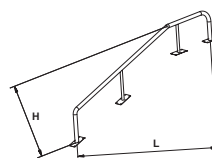

M5 600912

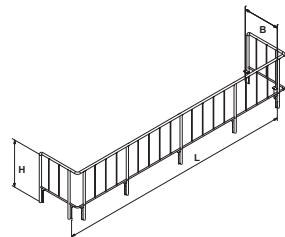

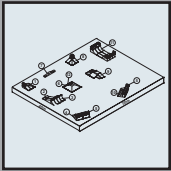
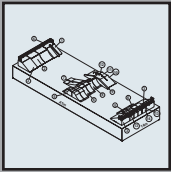
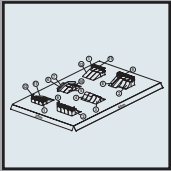
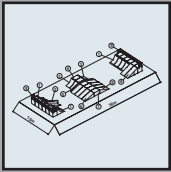
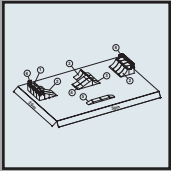
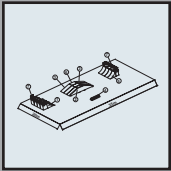
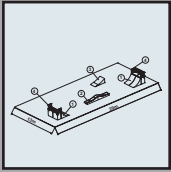
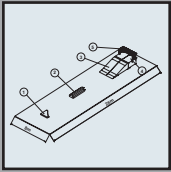

LATVIJAS FINIERIS

AKCIJU SABIEDRĪBA



A/S "Latvijas Finieris" Bauskas 59, Rīga, LV 1004, Latvia Tel.: +371 7067345 Fax: +371 7067388 e-mail: rampas@finieris.lv www.skateboard.lv

Made in EU, LATVIA